

PANEL CLASS pH - Redox 230V

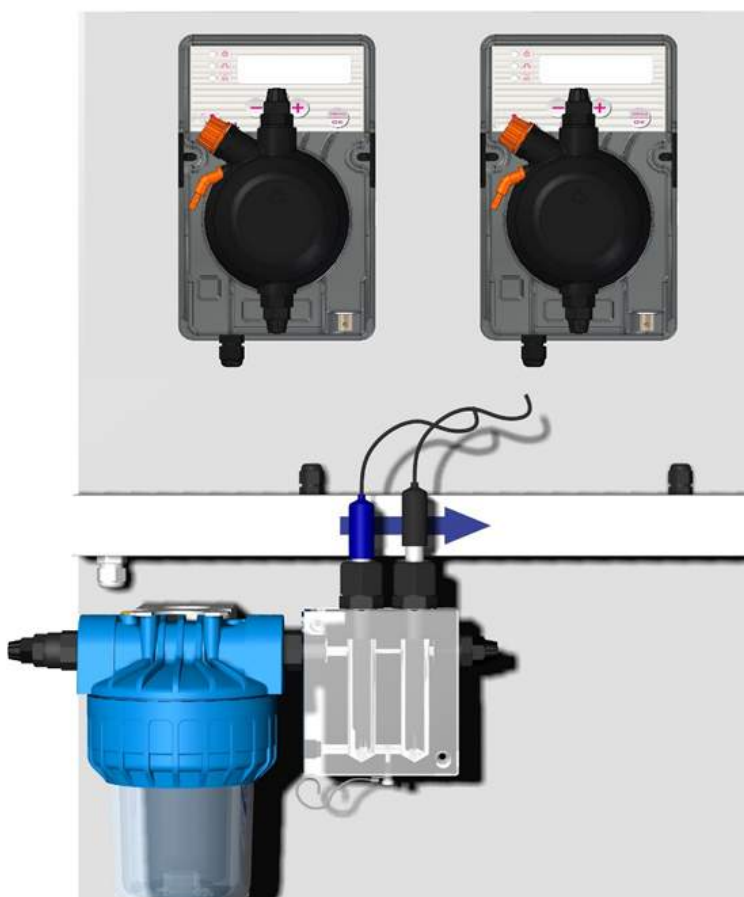

ES NORMAS DE INSTALACIÓN, USO Y MANUTENCIÓN

IT NORME DI INSTALLAZIONE, USO E MANUTENZIONE

EN OPERATING INSTRUCTIONS AND MAINTENANCE

FR NOTICE D'INSTALLATION, EMPLOI ET ENTRETIEN

PT NORMAS DE INSTALAÇÃO, USO E MANUTENÇÃO



(ES) DIRECTIVA "RAEE" 2002/96/CE Y MODIFICACIÓN SUCESIVA 2003/108/CE SOBRE RESIDUOS DE APARATOS ELÉCTRICOS Y ELECTRÓNICOS

El símbolo que se muestra abajo indica que el producto no puede eliminarse como un residuo urbano normal.

Los Aparatos Eléctricos y Electrónicos (AEE) pueden contener materiales nocivos para el medio ambiente y la salud y por tanto tienen que ser objeto de recogida selectiva: por consiguiente tienen que eliminarse en vertederos apropiados o entregarse al distribuidor cuando se adquiera uno nuevo, del mismo tipo o con las mismas funciones.

La normativa mencionada arriba, a la que remitimos para más detalles y profundizaciones, prevé sanciones por la eliminación clandestina de dichos residuos.

(IT) DIRETTIVA "RAEE" 2002/96/CE E SUCCESSIVA MODIFICA 2003/108/CE SUI RIFIUTI DI APPARECCHIATURE ELETTRICHE ED ELETTRONICHE

Il simbolo sotto riportato indica che il prodotto non può essere smaltito come normale rifiuto urbano.

Le Apparecchiature Elettriche ed Elettroniche (AEE) possono contenere materiali nocivi per l'ambiente e la salute e pertanto devono essere oggetto di raccolta differenziata: smaltite quindi presso apposite discariche o riconsegnate al distributore a fronte dell'acquisto di una nuova, di tipo equivalente o facente le stesse funzioni.

La normativa sopracitata, alla quale rimandiamo per ulteriori particolari e approfondimenti, prevede sanzioni per lo smaltimento abusivo di detti rifiuti.

(UK) WASTE OF ELECTRICAL AND ELECTRONIC EQUIPMENT DIRECTIVE (WEEE, RAEE in Italy) 2002/96/EC AND SUBSEQUENT AMENDMENT 2003/108/EC

The marking shown below indicates that the product cannot be disposed of as part of normal household waste.

Electrical and Electronic Equipment (EEE) can contain materials harmful to health and the environment, and therefore is subject to separate waste collection: it must be disposed of at appropriate waste collection points or returned to the distributor against purchase of new equipment of similar type or having the same functions.

The directive mentioned above, to which make reference for further details, provides for punitive actions in case of illegal disposal of such waste.

(FR) DIRECTIVE "RAEE" 2002/96/CE ET MODIFICATION SUCCESSIVE 2003/108/CE CONCERNANT LES REBUTS D'APPAREILLAGES ÉLECTRIQUES ET ÉLECTRONIQUES

Le symbole ci-dessous indique que le produit ne pas être éliminé comme un normal déchet urbain.

Les Appareillages Électriques et Électroniques (AEE) peuvent contenir des matériaux nocifs pour l'environnement et la santé et doivent donc faire l'objet de collecte différenciée: éliminés donc auprès de décharges prévues à cet effet ou rendus au distributeur pour l'achat d'un nouveau, de type équivalent ou ayant les mêmes fonctions.

La réglementation susmentionnée, à laquelle nous vous renvoyons pour les détails et les approfondissements ultérieurs, prévoit des sanctions pour la mise en décharge abusive desdits rebus.



COLORO LIBRE VS POTENCIAL REDOX (pH)

GRAFICO CLORO LIBERO VS POTENZIALE REDOX (pH)

FREE CHLORINE - OXIDATION REDUCTION POTENTIAL (ORP) - pH GRAPH

GRAPHIQUE CHLORE LIBRE VS POTENTIEL REDOX (pH) GRÁFICO

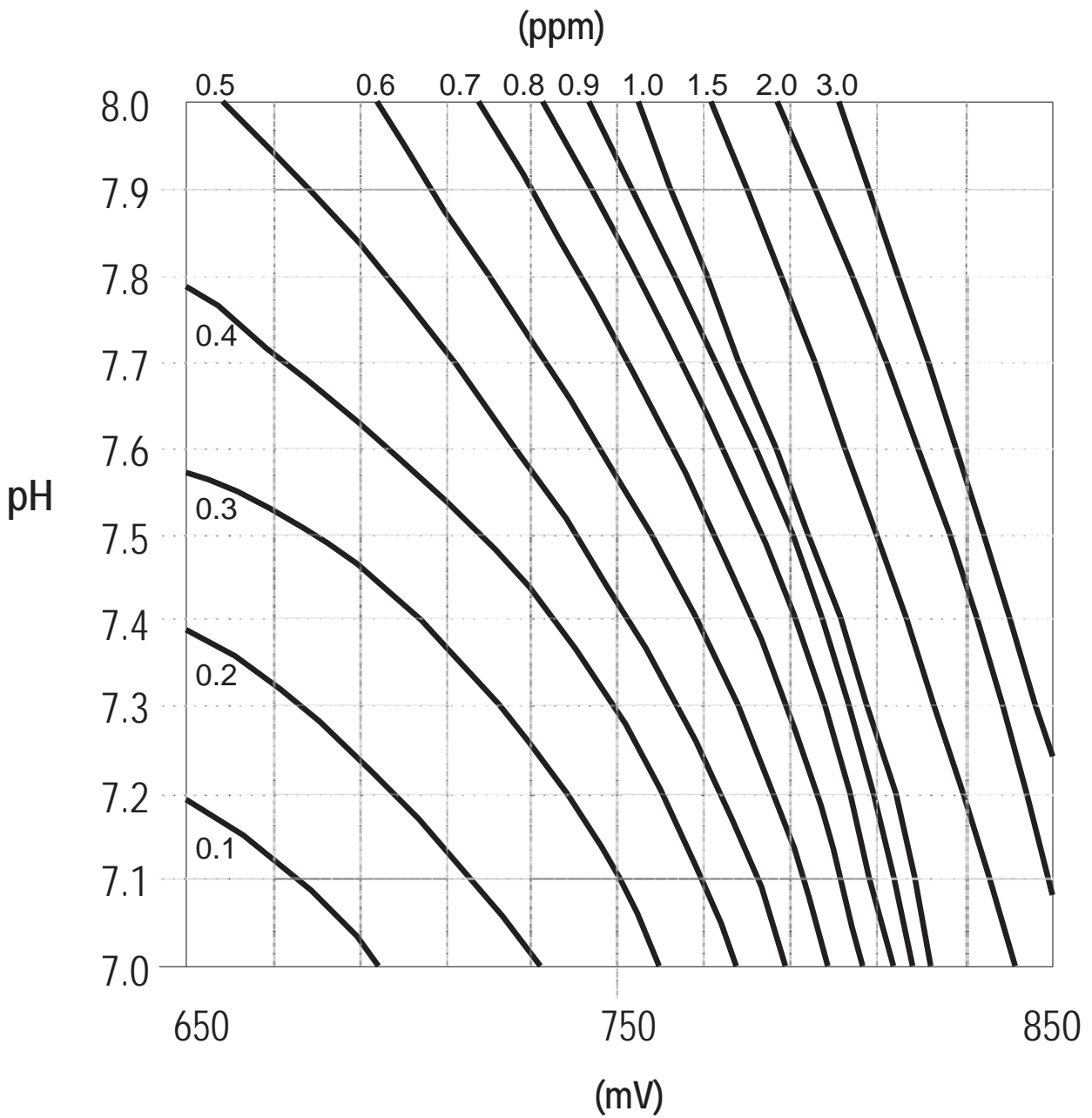

| | |
|---|-----------|
| INFORMATION REGARDING THE USE AND MAINTENANCE MANUAL | 41 |
| About the manual | 41 |
| Warnings | 41 |
| Symbols used in the manual | 41 |
| Symbols used on the panel | 42 |
| General Terms and Conditions | 42 |
| Copyright | 42 |
| GENERAL REQUIREMENTS FOR SAFETY | 42 |
| Manufacturer's statement of responsibility | 42 |
| Limits of use | 43 |
| Electrical safety | 43 |
| Safety of operating environment | 43 |
| Protection of the electronic section | 43 |
| Information on recycling and reuse of materials | 44 |
| Focus on critical components | 44 |
| GENERAL INSTRUCTIONS | 45 |
| Transport and handling | 45 |
| Risks | 45 |
| Assembly | 45 |
| Disassembly | 45 |
| Warranty | 45 |
| GENERAL DESCRIPTION | 46 |
| Introduction and description of the device | 46 |
| Hydraulic System | 47 |
| Technical specifications | 47 |
| Compliance | 47 |
| Operating Functions | 48 |
| Technical features of measurements: | 48 |
| Overall dimensions | 48 |
| ASSEMBLY AND INSTALLATION | 49 |
| Introduction | 49 |
| Package contents | 49 |
| Control panel installation | 49 |
| Hydraulic connection | 50 |
| pH and RX electrode assembly | 51 |
| Electrical connection | 52 |
| Downtime | 52 |
| OPERATING INSTRUCTIONS | 53 |
| Calibration and set-up of the components | 53 |
| ROUTINE MAINTENANCE | 53 |
| General cleaning of the station | 53 |
| Cleaning the water filters | 53 |

| | |
|---|-----------|
| General cleaning of the electrodes | 54 |
| Hydraulic system inspection | 54 |
| EXTRAORDINARY OPERATIONS IN CASE OF FAILURE..... | 54 |
| Mechanical failures | 54 |
| Electrical faults | 54 |
| ATTACHMENT 1 - SPARE PARTS..... | 55 |

INFORMATION REGARDING THE USE AND MAINTENANCE MANUAL

Dear customer, thank you for choosing the control station CONTROL PANEL pH-RX by CERTIKIN. Please read the contents of this instruction manual carefully. It has been specially designed to inform you, with warnings and advice, on the proper way to install, use and maintain the product in order to take advantage of all the features.

About the manual

This manual is an integral part of the device. At the time of initial installation of the device, the operator must carefully check the contents of the manual in order to verify its integrity and completeness.

If it is damaged, incomplete or incorrect, please contact CERTIKIN so as to promptly reinstate or replace the manual.

Compliance with the operating procedures and warnings described in this manual is essential for proper operation of the device and to ensure operator safety.

The manual must be carefully read in its entirety, in front of the device, as a preparatory phase for use so that its operating methods, controls, connections to peripheral devices and precautions for safe and correct use are clear.



The user manual must be kept intact and legible in all its parts, in a safe place and at the same time easily accessible by the operator during the installation, operation, maintenance and/or revision of the installation.

Warnings

PLEASE NOTE: The control station is built to perfection. Its durability, electrical and mechanical reliability, will be greater if it is used properly and maintenance is carried out on a regular basis.



ATTENTION: Any work or repairs inside the device must be carried out by qualified and authorised personnel. We assume no liability due to failure to comply with this rule.

Symbols used in the manual

| | | |
|--|--|--|
|  |  |  |
| FORBIDDEN Precedes information regarding safety. Indicates a forbidden operation | ATTENTION Precedes very important text to protect the health of persons exposed or to the machine itself | INFORMATION NOTE Precedes information concerning use of the device. It contains useful information for the operator to perform the operating procedures of the device properly and optimise its use. |

Symbols used on the panel

The following table shows the diagrams, relative description and location of all graphic symbols present on the panel and on any other device or external devices that can be connected.

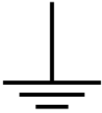
| | | |
|--|---|---|
|  |  |  |
| DANGEROUS VOLTAGE Symbol next to the terminals for connection to line voltage. | ATTENTION! CONSULT DOCUMENTATION Symbol placed at points where it is appropriate to refer to the user manual for important information. | DIRECTION OF PASSAGE Symbol placed in line with hydraulic components of the panel to show the flow direction of analysis water. |
| F | PHASE | Symbols placed in line with connection of the panel to the mains |
| N | NEUTRAL | |
|  | PROTECTIVE GROUND | |

General Terms and Conditions

Despite the utmost care in preparing this document, CERTIKIN cannot guarantee accuracy of all information contained herein and cannot be held liable for any errors that this could entail, nor for any damage that may result from use or application.

Products, materials, software and services in this document are subject to development in terms of presenting features and operation. CERTIKIN thus reserves the right to make any changes without notice.

Copyright

It is forbidden to reproduce or copy this manual, even partially, by any means without the express consent of CERTIKIN.

GENERAL REQUIREMENTS FOR SAFETY

Manufacturer's statement of responsibility

The CERTIKIN is considered responsible for safety, reliability and performance of the device if, and only if, it is used under the following conditions:

- calibration, modifications or repairs must be carried out by qualified personnel and expressly authorised by CERTIKIN;
- opening of the device and access to its internal parts must only be carried out by qualified maintenance personnel and specially authorised by CERTIKIN;
- the environment in which the device is used must comply with current safety regulations;
- the electrical system of the area where the device is located must be kept in perfect condition and carried out professionally in accordance with the rules in force in the country of use;
- for routine maintenance, only use original spare parts, otherwise the warranty will be rendered null and void;

- use and maintenance of the device and its accessories must be carried out in accordance with the instructions described in this manual;
- this manual must be kept intact and legible in all its parts.



Limits of use

The device is only intended for the use for which it was expressly built. Any other use is considered improper and therefore dangerous. The manufacturer declines all responsibility in the event of changes and/or electrical and hydraulic connection errors caused by failure to comply with the instructions in the installation, use and maintenance manual. Failure to comply with these instructions will immediately render the warranty null and void.

Any operations and/or repairs inside the device must be carried out by qualified and authorised personnel. We assume no liability due to failure to comply with this rule.

Electrical safety

In order to ensure maximum operator safety and correct operation of the device, you must operate within the limits allowed and take all the precautions listed below:

- **Before use, make sure that all safety requirements are met. The appliance must not be supplied or connected to other devices until the safety conditions are met.**
- **Power the device exclusively with mains voltage according to specifications (230Vac 50/60 Hz)**
- **Immediately replace damaged parts.** Cables, connectors, accessories or other parts of the device that are damaged or not operating properly must be replaced immediately. If so, contact your nearest authorised technical assistance service.
- **Only use the accessories and peripherals specified by CERTIKIN.** To ensure all safety requirements, you must only use the accessories specified in this manual or in those of individual devices assembled on the station, which have been tested with each other. Use of accessories and consumables from other manufacturers, or not specifically indicated by CERTIKIN, does not guarantee safety and correct operation of the device. Only use peripheral devices that meet the standards of its category.

Safety of operating environment

The CONTROL PANEL PH-RX is protected against liquids seeping in. Do not subject the device to the risk of dripping and splashing, and do not use the device in rooms where there are such risks. If liquids accidentally spill into the devices, they must be immediately switched off, cleaned and checked by authorised personnel.

On completion of installation and calibration, it is recommended to reposition the protection control panel of CONTROL PANEL PH-RX.

Protection of the electronic section

- Protection of the pump , IP65
- EMI/RFI IEC EN 61326 IEC EN 61010-1

Use the device within the environmental limits of temperature, humidity and pressure specified. The tool is designed to work in the following environmental conditions:

- Working ambient temperature 0°C ÷ +50°C
- storage and transport temperature -25°C ÷ +65°C
- relative humidity 10% ÷ 95%RH - Non-Condensing

The device must be perfectly installed in the system, which must be in accordance with the safety rules in force in the country of installation. The system must be maintained in full compliance with the safety rules provided for.



The parameters set on the control unit of the analyser must comply with the statutory and regulatory requirements. Reports of failure of the control unit must be placed in a room that is constantly controlled by operating personnel or assistance of the system.

Failure to comply with even one of these conditions can cause the "logic" of the control unit to operate in a potentially dangerous way for users of the service.

Therefore service personnel and/or maintenance technicians are recommended to operate with the utmost diligence, immediately reporting any deviation of the safety parameters so as to avoid potentially dangerous conditions.



Since the above considerations do not fall under the possibility of control by the product in question, the manufacturer is not responsible in any way for any damages that such malfunctions can cause to people or property.

Information on recycling and reuse of materials

In accordance with specific EU directives, CERTIKIN focuses on continuous improvement of the design and production process of its devices in order to minimise the negative impact on the environment with regard to management of component parts, supplies, packaging and the device at the end of its lifespan.

The packages are designed and produced in order to permit their reuse or recovery, including recycling of most materials, and to minimise the amount of waste or residues to be disposed of. To ensure proper environmental impact, this device was designed with maximum circuit miniaturisation, with the least possible differentiation of materials and components, with a selection of substances that guarantee maximum recyclability and maximum reuse of the parts and disposal without any ecological impacts.

The device is manufactured in such a way as to ensure easy separation or removal of materials containing pollutants compared to others, especially during maintenance and replacement of parts.

Disposal/recycling of packaging, supplies and the device itself at the end of its lifespan must be made in accordance with the regulations and standards currently in force in the country where the device is used.



Focus on critical components

An LCD (Liquid Crystal Display) is assembled inside the tool pumps and contains small amounts of toxic materials.

Transport and handling

Transport must be carried out respecting the orientation indicated on the package. Shipping by any means, even if free of carriage of the purchaser or recipient, is carried out at the purchaser's risk. Claim for missing materials must be made within 10 days of arrival of the goods. Whereas defective material within 30 days of receipt. If the control unit is to be replaced, it must be agreed upon with authorised personnel or the authorised distributor.



Risks

After removing the packing, check the integrity of the control unit. If in doubt, do not use the device and contact a qualified technician. The packing materials (such as plastic bags, polystyrene, etc.) must not be left within reach of children since they are potentially dangerous.

Before connecting the control unit, make sure that the rating corresponds to those of the mains. The rating is displayed on the adhesive label on the control unit itself.

Execution of the electrical system must comply with the standards that define professional workmanship in the country where the system is made.

Use of any electrical device implies observance of some fundamental rules. In particular:

- do not touch the device with wet or damp hands or feet;
- do not operate the device barefoot (e.g. pool systems);
- do not leave the device exposed to atmospheric agents (rain, sun, etc.)
- do not let children or an incapable person use the control unit unattended.

In case of failure and/or malfunctioning of the unit, switch it off and do not tamper with it. For any repairs, please contact our service centres and request use of original spare parts. Failure to comply with the above can jeopardise the safety of the device.

If you no longer decide to use an installed control unit, it is recommended to make it inoperable by unplugging it from the mains.

In case of any leaks in the hydraulic system of the control unit (breakage of OR seal, valves, pipes), you must stop operation by depressurising and disconnecting the supply pipes and then proceed with maintenance operations using appropriate safety measures.

Assembly

All control units manufactured by us are usually supplied fully assembled. For more clarification regarding exposure, please consult the attachment at the end of this manual where exploded drawings of the device and all parts with relative nomenclature is reported in order to have a complete picture of the components. These drawings are anyhow required to recognise the malfunctioning or defective parts. Other drawings regarding the internal parts are reported for the same purposes, also in the attachment.

Disassembly

To disassemble the control unit or before carrying out any operations on it, you must:

- make sure it is switched off electrically (both polarities), disconnecting the conductors from contact points of the mains by opening of the omnipolar switch with minimum 3 mm distance between the contacts ();
- disconnect any pumps and other devices connected to it;
- close or disconnect the hydraulic supply circuit and discharge filters and probe holders.



Warranty

2 years (excluding parts subject to normal wear, namely: valves, fittings, pipe collars, tubes, seals and filter). Improper use of the device will void this warranty. The warranty is understood as ex-works or authorised distributors

GENERAL DESCRIPTION

Introduction and description of the device

Swimming pool water must be constantly kept under control to ensure the highest quality. CERTIKIN has developed a comprehensive monitoring system. This system incorporates a control part (electronic tool pumps) and hydraulic part (flow valves, filters, etc.). The 2 metering pumps dose the products; one is there to adjust the pH and the other doses hypochlorite.

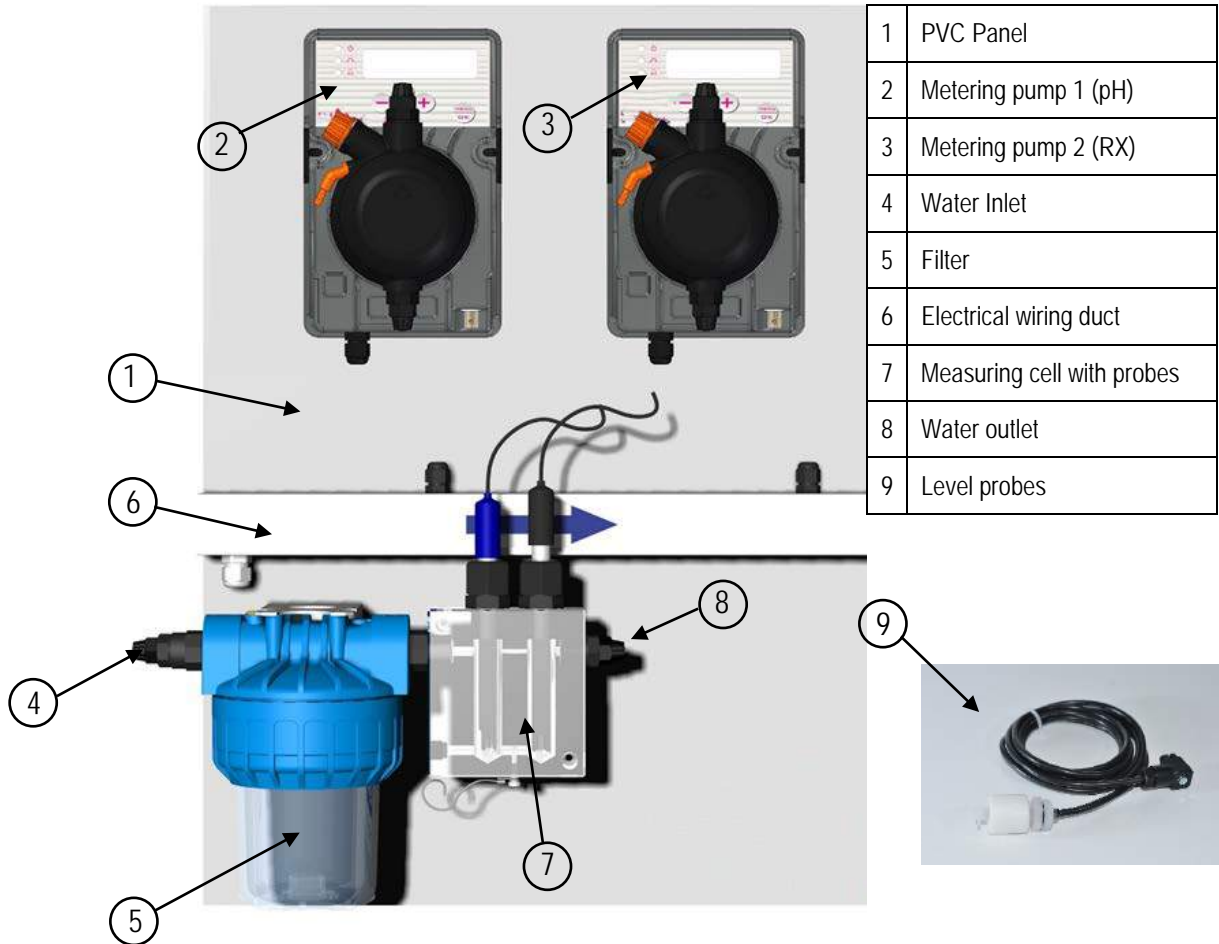
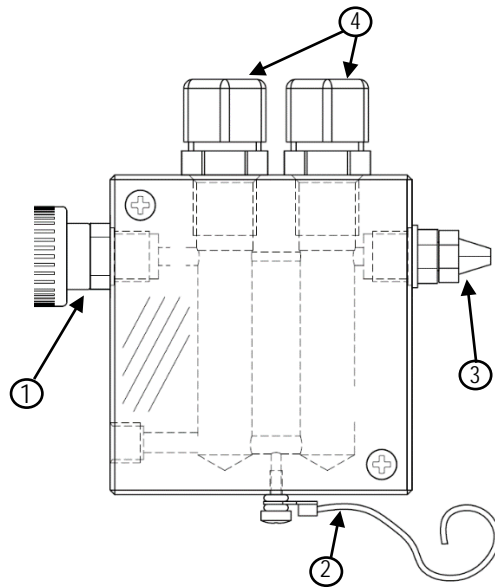

Figure1 – CONTROL PANEL PH-RX

Hereunder is a brief description of how the water flows through the control station and is monitored (to facilitate understanding, refer to Figure1).



The water coming from a shunt of the pool's recirculation system enters through the sampling **water inlet** (Figure1– pos. 5) then flows inside the **water filter** (Figure1– pos. 6), which keeps any impurities or suspended parts, and from there into the unit (Figure1– pos. 7) responsible to check the different chemical/physical values (depending on the type of sensor that is installed), such as the acidity/alkaline properties and oxidation reduction potential. All this is managed by a sophisticated control unit (Figure1– pos. 2) installed on the control station, which, depending on the readings, enables and/or disables the relative devices (Figure1– pos. 3 and 4) connected to it, unless the level switches (Figure1– pos. 10) trigger (if any) placed in the respective suction tanks or (where applicable) the flow sensor (refer to the next paragraph)



| | |
|---|--------------------------------|
| 1 | Sample water Inlet |
| 2 | Ground cable |
| 3 | Outlet water pipe ring fitting |
| 4 | Electrode D12 seat |

Figure 2 - Probe holder

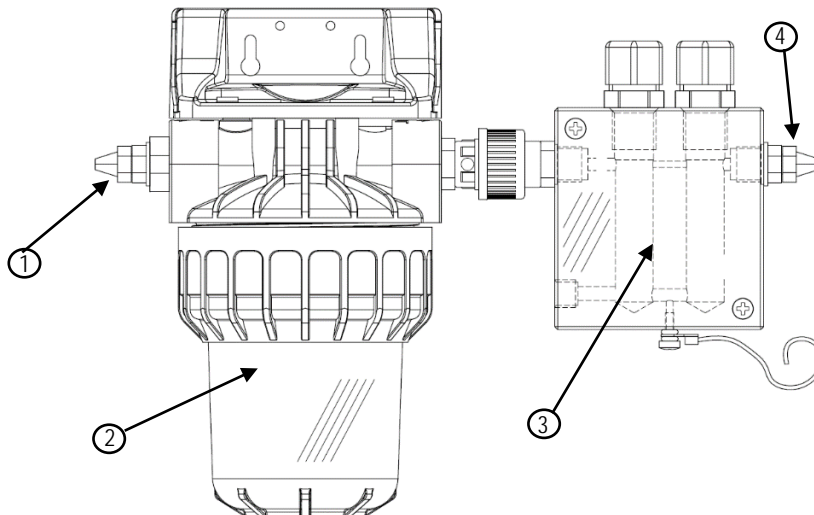

| | |
|---|-------------------|
| 1 | Water flow inlet |
| 2 | In-line filter |
| 3 | Electrode holder |
| 4 | Water flow outlet |

Figure3 – Hydraulic part

Technical specifications

- Device manufactured in compliance with European CE directives.
- Control panel assembled on a rigid PVC sheet
- Power supply 230 V 50-60 Hz
- Protection grade: IP65 (instrument metering pumps), IP55 (junction box), IP2X (outer container)
- Environmental conditions: closed environment, maximum altitude 2000 m, ambient temperature from 5°C to 40°C, maximum relative humidity 80% up to maximum 31° C (decreases linearly until reaching 50% at 40°C)
- Classification with regard to protection against direct contacts: CLASS I, the device is provided with a protective conductor

Compliance

The device complies with the following directives:

- 2006/95/EC: "Low voltage"
- 2004/108/EC: "Electromagnetic compatibility"

Operating Functions

| Code | Description | Features |
|--------------|-----------------------------------|----------|
| QPA5S11001CT | PANEL CLASS PH 5-7 - RX 10-5 230V | |

Every time the device is started, the two tool pumps display the firmware version installed for a few seconds.

Technical features of measurements:

| <i>PH</i> | |
|--------------------------|------------------|
| Principle of measurement | Potentiometer |
| Measuring range | 00.00 ÷ 14.00 pH |
| Resolution | ± 0.01 Ph |
| Accuracy | ± 0.2% F.s. |
| Repeatability | 98% |
| Input impedance | > 10 GOhm |
| Polarisation | < 1 pA |
| <i>REDOX</i> | |
| Principle of measurement | Potentiometer |
| Measuring range | 0-2000mV |
| Resolution | ± 1mV |
| Accuracy | ± 0.2% F.s. |
| Repeatability | 98% |
| Input impedance | > 10 GOhm |

For further details, refer to the specific manual of the tool pumps installed on the panel

Overall dimensions

The overall dimensions of the panel are 450x600 (see Figure 4)



Introduction

This section describes the steps to install the control unit and for electrical connection. Read the instructions carefully before starting any operations.

Follow these guidelines when installing:

- Before starting any operations, make sure that all the devices are switched off and disconnected from the mains.
- If you detect any faults or dangers, stop immediately. Resume operations only if you are absolutely sure that the reason for the failure or danger has been removed.
- Do not install the device in dangerous areas or that risk explosion or fires.
- To avoid risk of electric shock, do not use old and worn material.

Package contents

Control panel installation

Install the control panel away from heat sources and possibly in a dry place without splashes of water and protected against dripping, at temperatures below 40°C. The minimum temperature must not be below 0°C.

The control panel must be installed making sure to leave enough space for the wires and connections.

The CONTROL PANEL PVC PH-RX support plate comes with 4 holes near the corners in order to wall-mount the station. Figure4 shows the drilling centre distances and dimensions of the panel (dimensions in mm).

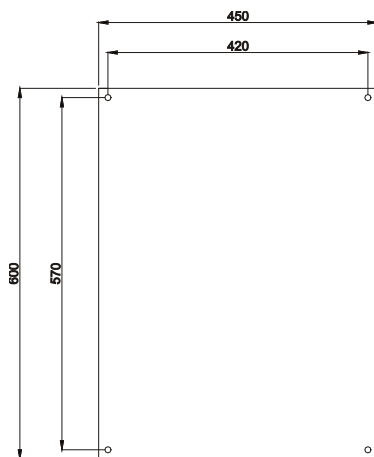

Figure4 - Wall-mounting hole position of the plate 450x600 mm

If appropriate, use the supplied anchor screws, otherwise choose an appropriate type. The station is supplied already assembled and wired internally.

The wall must be as straight as possible and free of bumps to ensure optimal support of the instrument.

Firstly, it is recommended to drill two holes aligned horizontally at a height that enables the operator to view the control panel correctly, and an easy position for calibration and control. We recommend a height of approximately 180 cm from the floor, or at eye level. The distance between the two holes must be 420 mm. During installation, it is recommended to use a spirit level to install the control panel.

Hydraulic connection

A typical example of installation in the system can be summed up in Figure 6

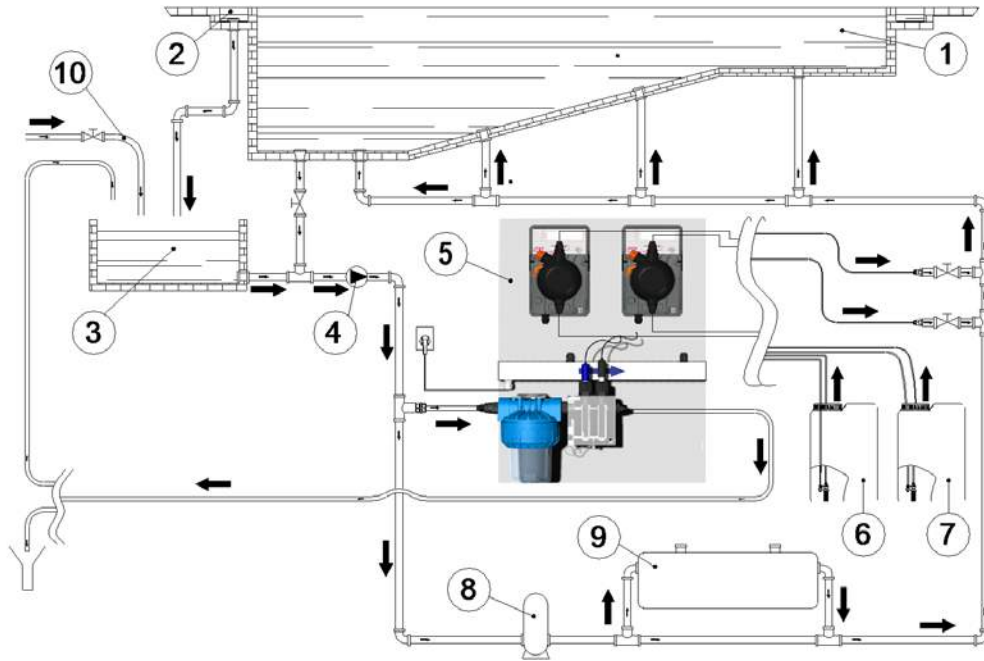

- | | | | |
|---|------------------------|----|----------------------------|
| 1 | Pool | 6 | Ph controller product tank |
| 2 | Spillway channel | 7 | Sodium hypochlorite tank |
| 3 | Recovery tank | 8 | Filter |
| 4 | Pump | 9 | Heat exchanger |
| 5 | CERTIKIN control panel | 10 | Water top-up |

Figure 5 – Typical diagram of installation



The water sample must be conducted at the water sampling station using PVC or PE pipes. Metal pipes must not be used for any reason since they can significantly alter the value of the chemical parameters of the water. In fact, chlorine reacts with metal pipes.

The water sample must reach the sampling station with the least possible delay in order to ensure effective monitoring of the quality of water.

The sampling line should be as short as possible and have a small flow section. A length of 25 meters and a section of DN6 is enough to cause a delay of about 1 minute. The delay increases to 5 minutes if the line itself has a cross section of DN 15. Therefore, use of larger sections, despite being useful to reduce pressure drops, causes instrument reading delays.

Applicable regulations must be complied with when sampling water. When samples of water are collected from a pipe, they must be taken from the middle of the pipe itself, as shown in Figure 6

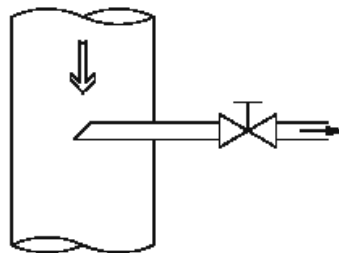

Figure 6 – Detail of sampling point

Installing a pre-filter of 50-80 μm upstream of the one installed on the station is often recommended, particularly in the case of outdoor swimming pools where the water is sampled directly from the pool



The filters must be cleaned at regular intervals and replaced so that measurements are not disturbed by the consumption of chlorine that would otherwise take place.

Use of a pump can also be recommended when water sampling is not pressurised. This system also helps prevent long delays even when the sampling point is at a considerable distance from water sampling.

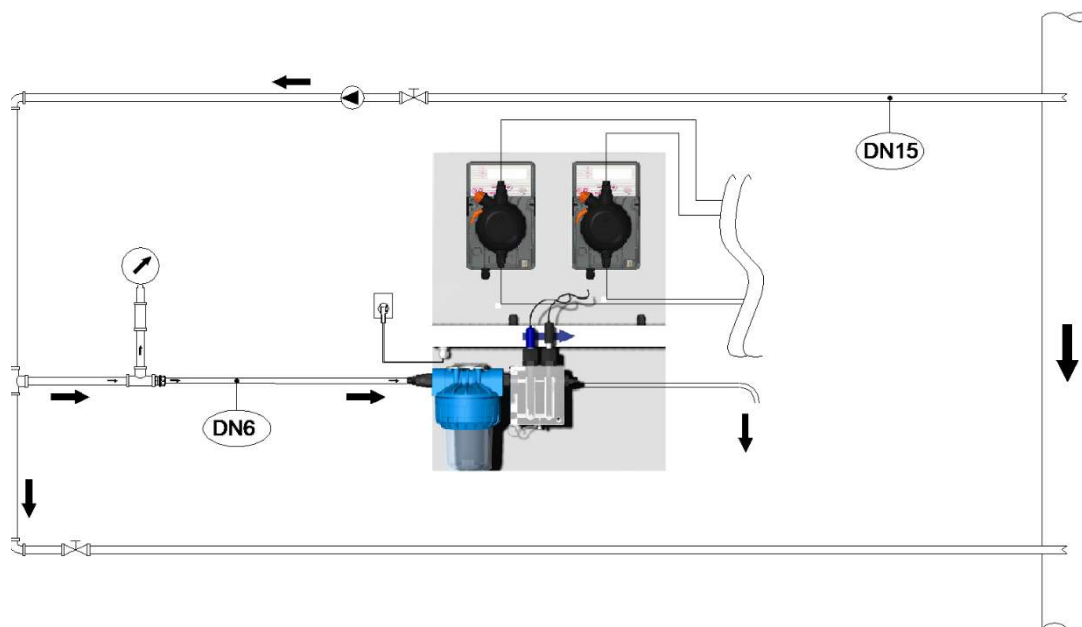

Figure 7 – Typical installation with a recirculation pump

Figure 7 shows how the pump transports the water over a long distance, but only part of the flow is used for actual measurement. In no event must the throttle valve be completely closed, otherwise the long delay can make it more difficult to control. Also, the water might heat up significantly in the pump, and thus lead to incorrect measurements. A pressure meter in the sampling node is useful to regulate the throttle valve.

Draining water from the sampling station is at almost nil pressure. The water must be able to drain freely. On the other hand, a pump must be installed if the water sample goes back to a pressurised system.

With reference to Figure3, respectively connect:

- Pos 1: supplied water inlet pipe 4 x 6
- Pos. 4: measuring cell output, 4 x 6 supplied pipe.

pH and RX electrode assembly

To assemble the electrodes (Figure 8, pos. D), proceed as follows:

- Loosen the ring nuts of the relative electrode holders.
- Remove the protective caps of the sensitive membrane of the electrodes.
- Insert the electrodes, being careful to leave less than 10 mm from the bottom of the Plexiglas seat in the probe holder (Figure 8, pos. A)
- Be careful to make sure that the distance indicated by "B" is more than 2 mm.
- Manually tighten the ring nuts (Figure 8, pos. C), being careful to avoid breaking the transparent plastic of the said electrodes

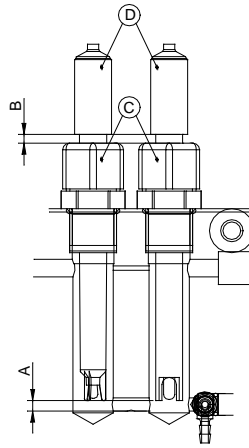

Figure 8 - Detail of the pair of electrodes assembly



The protection caps of the electrodes' sensitive membrane should be stored in a safe place as it will help keep its moisture if the water sampling station must be turned off for an extended period.

A similar assembly procedure applies to the electrode to measure the temperature (not included), which can be installed in the relative seat of the probe holder by replacing the cap with the supplied fitting.

Electrical connection



Electrical installation must be carried out in accordance with the standards in force in the country of use. If the power cables do not have a plug, the device must be connected to the mains via an interposed omnipolar cut-out switch with minimum distance between contacts of at least 3 mm. **Before accessing each powered device, make sure the mains power supply has been disconnected (Figure 9).**

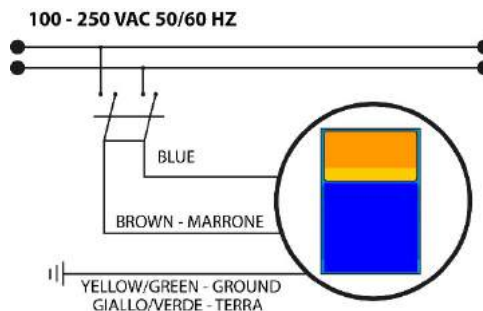

Figure 9 – Electrical connection – inputs 1 and 2



The control panel is supplied already wired internally.

It is advisable to power the control station separately from other devices that may cause interference. For example, heavy inductive loads (recirculation pumps) or frequency driven device (inverters).

Downtime

Sequence of steps to carry out before long periods of downtime:

- Turn off both tool pumps
- Close the input and output valves to the measuring cell
- Make sure the electrodes are immersed in a sufficient amount of water, otherwise loosen the ring nuts, remove them and leave them to soak in water or preferably in a KCL preservation solution.

OPERATING INSTRUCTIONS

Calibration and set-up of the components

For CONTROL PANEL PH-RX installation operations, refer to these operating instructions.

For wiring, calibration and pump operation setting of tool pump functions, refer to the pumps' manual included in the package.

For all other installation and adjustment procedures of the probes/electrodes, refer to their use and maintenance manuals.

ROUTINE MAINTENANCE



Periodic maintenance must be carried out in order to obtain maximum performance of the control station. We also recommend that you follow our maintenance programs and join a scheduled service with one of our Authorised Service Centres.

The following is a general table indicating the maximum time of maintenance intervals.

| | TIME INTERVALS | | | |
|---------------------------------|----------------|----------|----------|----------|
| | 1 month | 2 months | 3 months | 6 months |
| General cleaning of the station | | | | X |
| Water net filter cleaning | X | | | |
| Probe cleaning | X | | | |
| Hydraulic system inspection | | X | | |

Tab. 1 – Recommended maintenance intervals

Control station maintenance intervals are defined by the conditions in which it operates. More precisely, the information in the maintenance table is indicative since it refers to a theoretical system. In fact, each system according to the way it is structured has its own maintenance requirements. Therefore, the maintenance technician must evaluate the interval of time for any replacement of parts.



Before carrying out any of the maintenance operations listed below, electrically disconnect the control station from the line's switch where it is located.

Before carrying out any of the maintenance operations listed below, stop the flow of water that reaches the station from the system and depressurise it by completely opening the sampling valve.

General cleaning of the station



Periodically clean all surfaces of the station. Only use a damp cloth without adding any solvent or product.

Cleaning the water filters

Wait until no water comes out from the hydraulic system. Loosen the filter unit tray and remove the filter cartridge placed inside, being careful not to lose the relative seals. Place the cartridge under running water and, using a soft brush, remove all impurities from the filter. Reassemble the filter cartridge and the filter tray on the system, being careful to reposition the seals correctly. Completely close the sampling valve and restore the water flow in the circuit, gradually opening the valves and by bleeding air from the system. Connect the control station again and check the operating conditions after it carries out the initial test.

General cleaning of the electrodes



Always refer to the instructions manual of the electrodes.

Wait until no water comes out from the hydraulic system. Disconnect the electrode wires by removing the respective connectors at their ends and fastening rings and extract them from the probe holders present in the hydraulic circuit of the control station. Wash the sensitive end with warm water and neutral soap, removing any grease residues using a soft bristle brush.

To clean the probes, do not rub them with abrasive objects or cloths that can electrostatically charge them.

If the electrodes are very dirty, they can be cleaned with Denatured Alcohol. On completion of cleaning operations, reconnect the electrodes with their respective cables and calibrate them without restoring the water flow to the control station. After calibration operations, electrically disconnect the control station and reassemble the electrodes in the electrode holder. Restore power supply and the water flow to the control station after having closed the sampling valve.

Hydraulic system inspection

Visually check the entire hydraulic circuit of the control station after it has been electrically disconnected. In the presence of liquid leaks, damage to piping or any seal problems, intervene on the hydraulic circuit only after having stopped the flow of water that reaches the station and having depressurised the system by opening the sampling valve. Replace the damaged parts only with original spare parts.



Do not leave impurities inside the hydraulic circuit, which can clog it.

Close the sampling valve before restoring the water flow to the station. Gradually restore system pressure and then power the control station again.

EXTRAORDINARY OPERATIONS IN CASE OF FAILURE



All components supplied by us are chosen and tested according to strict principles of selection and thus guarantee reliability and operation with our devices for a long time.

Mechanical failures

Since the system is robust, actual mechanical failures do not occur. Liquid can at times leak from a loose fitting or ring nut, or if the water supply pipe bursts. After eliminating the leak, you must clean and dry the control station from any water, which, in the event of stagnation, can damage the parts in contact.

THE FLOW INSIDE THE MEASURING CELL IS INSUFFICIENT

- Check the tightness of the O-rings
- Check the status of filter clogging;
- Check the inlet and outlet valves
- Check the sampling valve.

Electrical faults



NO LIGHT SIGNAL, DISPLAY OFF.

- Make sure the control station is powered correctly (socket and plug). If the control station remains off, contact our Assistance Centres.

INCORRECT MEASUREMENTS

- Carefully check the calibration. If in doubt, reset to bring the instrument back to its default settings.
- Check correct operation of the probes and their possible wear

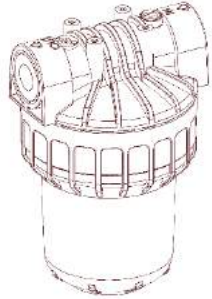
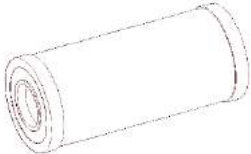
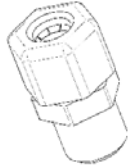
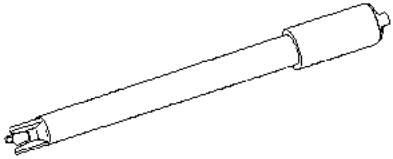
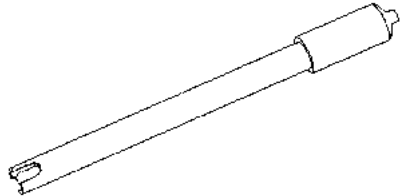
ATTACHMENT 1 - SPARE PARTS

| Code | Description | Figure |
|------------|-----------------------------|--|
| 1FLT001 | Complete filter |  |
| LRL1500005 | Filter Cartridge |  |
| DPS0002301 | Probe holder PP 1/2" |  |
| AEL0004922 | PH Electrode |  |
| AEL0005022 | RX Electrode |  |
| ASZ0000201 | pH7 Buffer solution |  |
| ASZ0000301 | pH9 Buffer solution | |
| ASZ0001501 | REDOX buffer solution 650mV | |
| 2003009 | Polyethylene pipe 4x6 (5m) |  |
| 2003004 | Crystal pipe 4x6 (4m) | |
| 2003007 | Polyethylene pipe 4x6 (2m) | |